



HEIDENHAIN



Product Information

EIB 3392 F

Signal Converter
in Cable Design

EIB 3392 F

Signal Converter in Cable Design

- **Input:** HEIDENHAIN encoders with EnDat22 interface
- **Output:** Fanuc Serial Interface

Application

The EIB 3392 F enables the connection of encoders with the EnDat22 ordering designation to controls with a Fanuc Serial Interface. Areas of application of the EIB 3392 F:

- Machines or automated systems that use HEIDENHAIN encoders and controls from various manufacturers
- Rotary tables for connection to different control systems

In these applications, the storage costs for production and servicing can be reduced. Testing systems, such as for the acceptance testing of a rotary table, can be reduced to the EnDat interface. This saves hardware and software maintenance costs.

Encoder requirements

After switch-on, the EIB tests various characteristics of the connected encoder and automatically adapts itself to it. If the encoder does not meet the necessary requirements, then an error message is issued via the Fanuc interface.

The resolution after implementation of the interface with the EIB 3392 F is oriented toward encoder variants with an integrated Fanuc interface. The resolution between Fanuc α_i and Fanuc α may also differ (see following table). The output speed of the position data is identical, regardless of whether an encoder with an integrated Fanuc interface is used or an EnDat encoder with the EIB 3392 F.

EIB 3392 F ordering designation

The ordering designation defines the details of the Fanuc interface version. The EIB 3392 F supports the ordering designation "Fanuc05". The multiturn encoders that support an external temperature sensor are an exception. In this case, output is performed in accordance with the ordering designation "Fanuc06".

Information about Fanuc α

For absolute angle encoders and singleturn rotary encoders, the "high resolution format B" is always used. This may differ from an encoder with an integrated Fanuc interface, such as the RCN 2001 angle encoder. For this reason, a conformity test should always be performed in advance. Please contact HEIDENHAIN for more information.

	EnDat encoder measuring step or position values per revolution	Fanuc α_i output measuring step or position values per revolution	Fanuc α output measuring step or position values per revolution
Absolute linear encoders ¹⁾ e.g.: LIC 4100, LIC 3100, LIC 2100	Measuring step in nm is converted 1:1		
Exception ²⁾ LC 115, LC 116, LC 415, LC 416, LC 211	1 nm 10 nm	1.25 nm 12.5 nm	10 nm 50 nm
Absolute angle encoders and singleturn rotary encoders e.g.: RCN 2001, RCN 5001, RCN 8001, RCN 6000 ROC 2000, ROC 7000 ECN 2000 ECA 4000 ECM 2400 MRP 2000, MRP 5000, MRP 8000 SRP 5000 ECN 100 ECI 100, ECI 1100, ECI 1300	≤ 27 bits ³⁾ : position values per revolution are converted 1:1		
	28 bits ³⁾ 29 bits ³⁾ 30 bits ³⁾ 31 bits ³⁾		27 bits ³⁾ 27 bits ³⁾ 27 bits ³⁾ 27 bits ³⁾
	> 31 bits ³⁾	Not supported	
Absolute multiturn rotary encoders ⁴⁾ e.g.: EQI 1100, EQI 1300	Position values per revolution or the revolutions are converted 1:1		Not supported
Incremental EnDat encoders e.g.: ERM 2400, LIP 200, EIB 100, EIB 300, EIB 1500	Not supported		
Encoders with battery-buffered revolution counters e.g.: EBI 100, EBI 1100, EBI 4000	Not supported		

¹⁾ Only encoders with an integer measuring step in nm are supported

²⁾ Older LC encoder generations are not supported

³⁾ Depending on the encoder: please note the information about Fanuc α

⁴⁾ Only 12 bits, gear-based multiturn

Specifications	EIB 3392 F
Input	
Interface	EnDat 2.2
Ordering designation	EnDat22 (note the <i>Encoder requirements</i>)
Electrical connection	Various connectors (see <i>Versions of the EIB 3392 F</i>)
Encoder supply voltage (U_{P2})	Directly passed on from U_{P1}
Cable length	≤ 30 m ¹⁾
Output	
Interface	Fanuc Serial Interface
Ordering designation	Fanuc05/Fanuc06 (only multiturn encoders)
Electrical connection	Various connectors (see <i>Versions of the EIB 3392 F</i>)
Cable length	≤ 30 m ¹⁾
Supply voltage (U_{P1})	DC 3.6 V to 14 V
Power consumption (only EIB 3392 F, without encoder)	<i>Maximum</i> At 3.6 V: 600 mW At 14 V: 700 mW <i>Typical</i> At 5 V: 500 mW + 1.15 x P_{Mtyp} (with P_{Mtyp} = Typical power consumption of the encoder)
Elevation	≤ 2000 m
Operating temperature	0 °C to 60 °C
Storage temperature	-30 °C to 70 °C
Vibration 55 Hz to 2000 Hz Shock 11 ms	100 m/s ² (IEC 60068-2-6) 200 m/s ² (IEC 60068-2-27)
Protection rating EN 60529	IP65 ²⁾
Mass	≈ 0.2 kg (with 1 m cable length on both sides)

¹⁾ With HEIDENHAIN cable; note the supply voltage on the encoder

²⁾ Use the correct connector version

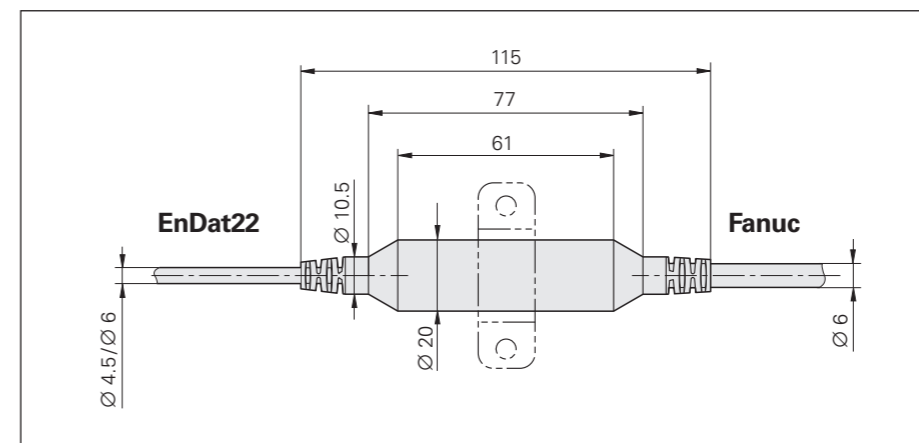

Versions of the EIB 3392 F

Overview of connection options (the encoders are examples)

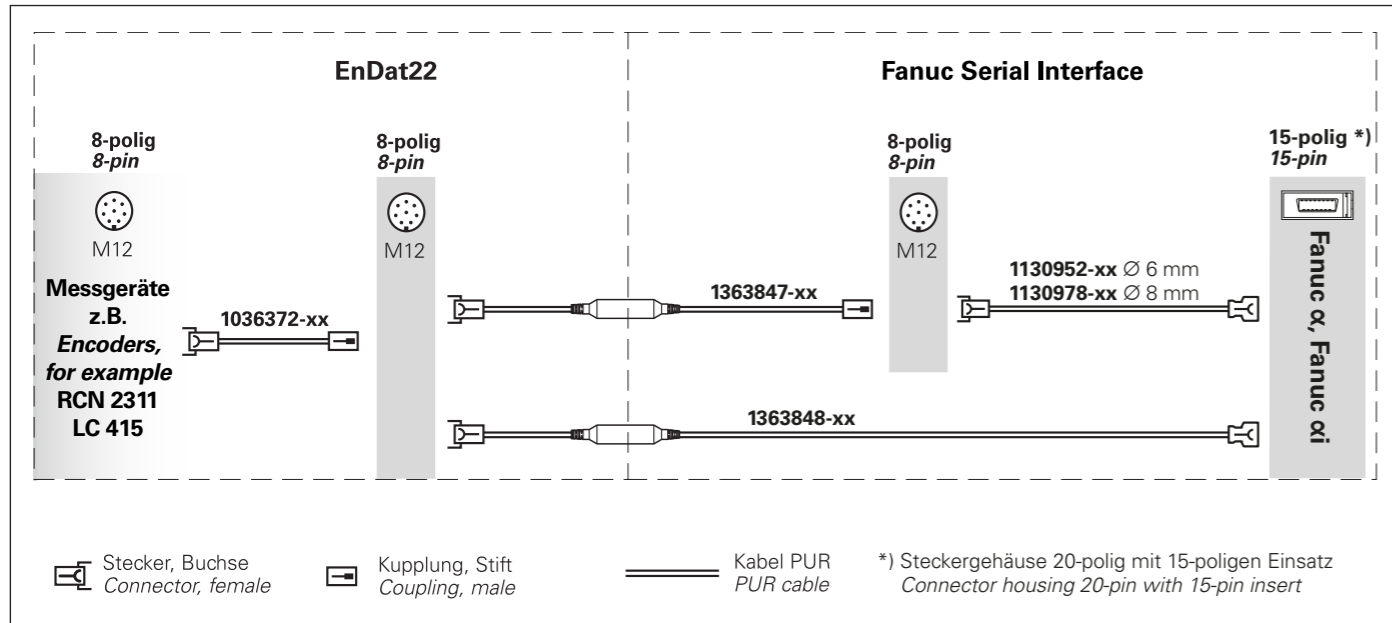

Overview of ID numbers for the EIB 3392 F

ID	Input			Output		
	Connecting elements	Cable Ø/A _p	Cable length	Connecting elements	Cable Ø/A _p	Cable length
1363847-01	8-pin M12 connector (female)	6 mm/ 2 x 0.16 mm ²	1 m	8-pin M12 connector (male)	6 mm/ 2 x 0.16 mm ²	1 m
1363848-01	8-pin M12 connector (female)	6 mm/ 2 x 0.16 mm ²	0.5 m	15-pin Mini Delta Ribbon connector (female)	6 mm/ 2 x 0.16 mm ²	2.5 m

A_p: Cross-section of wires for power supply voltage
Other versions are available upon request

Mounting the encoder

The encoder is mounted directly via the EnDat interface (e.g., with the PWM 21) without the EIB 3392 F. The "set datum" function is not supported by the EIB and may need to be performed directly in the encoder via the EnDat interface.

Temperature sensor information

The EIB 3392 F does not have a temperature sensor input, but it can evaluate the temperature sensor information from connected EnDat encoders and forward it via the Fanuc interface. The EIB 3392 F supports transmission of the following data:

- Temperature sensor inside the encoder
- External temperature sensor

For more information on the availability, configurability of the sensor evaluation and mapping of the temperature sensor information, see the documentation of the connected EnDat encoder.

Online diagnostics

With EnDat 2.2 encoders, valuation numbers can be read cyclically from the encoder in order to evaluate its functioning. The valuation numbers provide the current state of the encoder and ascertain the encoder's "function reserves". The function reserves are also transmitted via the Fanuc interface and can be displayed in the higher-level control. Further information is available from HEIDENHAIN upon request.

PWM 21 + ATS software

In Monitoring mode, the "monitoring identifier" must be provided. See also the EIB Mounting Instructions.

PWT 101

Due to the characteristics of the Fanuc interface in its interaction with the PWT 101, singleturn encoders are displayed as multiturn encoders in the "Encoder information" view in the "Encoder type" line.

Mounting direction

The EIB 3392 F must be fastened. This is possible, for example, with a 20 mm cable clamp (see also "Dimension drawing").

Power supply of encoder

The EIB 3392 F passes on the supply voltage from the control to the encoder. Please comply with the supply voltage range of the connected encoder.

Switch-on conditions

The switch-on time consists of the sum of the switch-on times of the encoder (see the Product Information document or the *Interfaces of HEIDENHAIN Encoders* brochure) and the EIB 3392 F (approx. 800 ms).



Note:

For functional safety, the MTTF values of the encoder and the EIB 3392 F must be added.

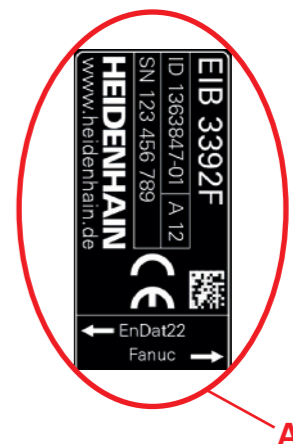

Designation of the connecting cables

The interfaces and their ordering designations "EnDat" and "Fanuc" are printed on the ID label. Arrows indicate the proper connection.





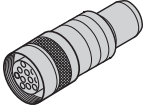
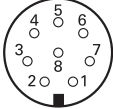

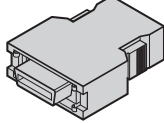
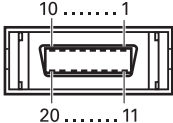

Interfaces

Pin layout of the EIB input

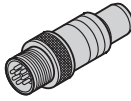
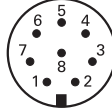
8-pin M12 coupling								
								
	Power supply				Serial data transmission			
	8	2	5	1	3	4	7	6
EnDat	U _{P2}	Sensor U _{P2}	0V	Sensor 0V	DATA	DATA	CLOCK	CLOCK

Fanuc pin layout

15-pin Fanuc connector					8-pin M12 coupling				
									
	Power supply					Serial data transmission			
	9	18/20	12	14	16	1	2	5	6
	8	2	5	1	Housing	3	4	7	6
	Brown/Green	Blue	White/Green	White	/	Gray	Pink	Violet	Yellow
	U _P	Sensor U _P	0V	Sensor 0V	Shield	Serial Data	Serial Data	Request	Request

U_P = Power supply

Sensor: The sense line is connected in the encoder with the corresponding power line.

Vacant pins or wires must not be used!

For the shield connection of the Fanuc connector, see also *General electrical information* in the *Interfaces of HEIDENHAIN Encoders* brochure.

HEIDENHAIN

DR. JOHANNES HEIDENHAIN GmbH

Dr.-Johannes-Heidenhain-Straße 5

83301 Traunreut, Germany

+49 8669 31-0

+49 8669 32-5061

E-mail: info@heidenhain.de

www.heidenhain.de

This Product Information document supersedes all previous editions, which thereby become invalid. The basis for ordering from HEIDENHAIN is always the Product Information document edition valid when the order is placed.



More information:

To ensure proper and intended use, comply with the specifications in the following documents:

- Brochure: *Interfaces of HEIDENHAIN Encoders* 1078628-xx
- Brochure: *Cables and Connectors* 1206103-xx
- Operating Instruction: *EIB 3392F* 1378361-xx
- Brochure, Product Information, and Mounting Instructions of the connected encoder